

INSTALLATION INSTRUCTIONS

SAVE THESE INSTRUCTIONS

PREPARING THE LUMINAIRE

NARROW RECESSED DOWN LIGHT:

Model: LG-7001 - 1X1 NARROWLINE TRIMMED SQUARE DOWNLIGHT

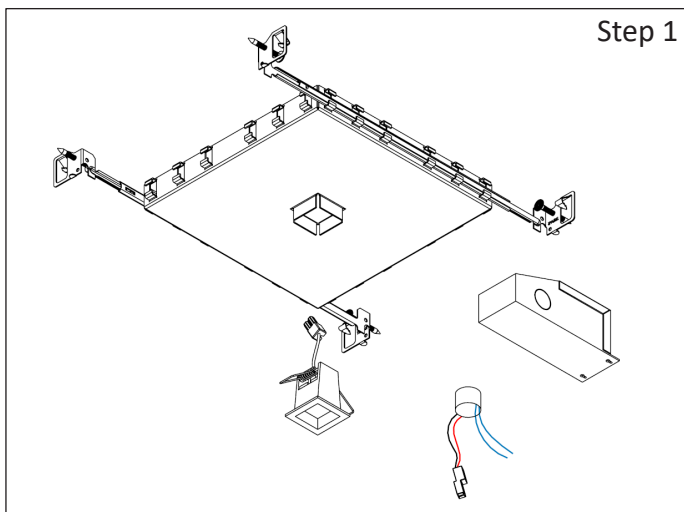

Step 1 - Luminaire Parts and Tools for Installation:

a. Unpack all Fixture Part and get to know them for easy Installation.

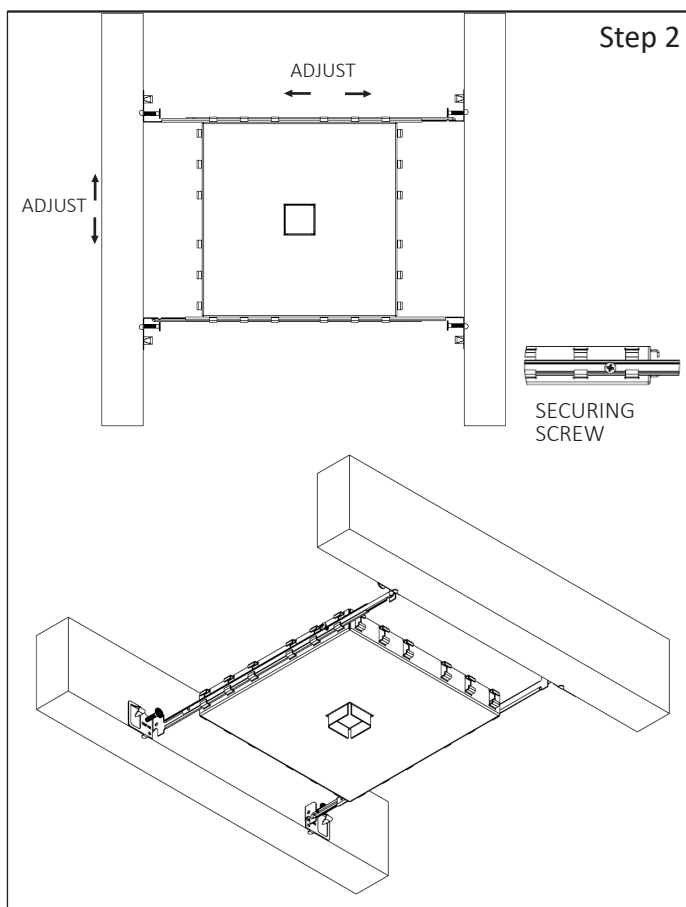

Step 2 - Align Plaster Frame to Wood Joist:

- Select the location to Install this Fixture on Ceiling.
- Place Hanger Bar to Wood Joist and secure using the captive Nails.
- Adjust Plaster Frame to desire location and lock position using screw (provided).

READ AND UNDERSTAND ALL INSTRUCTIONS BEFORE INSTALLATION. IF YOU ARE NOT FAMILIAR WITH THE NATIONAL ELECTRICAL CODE (NEC), CONTACT A QUALIFIED ELECTRICIAN TO INSTALL THIS LUMINAIRE.

WARNING - Before installing this luminaire or doing any maintenance, turn off the power supply at the circuit breaker or fuse box. Turning the power off using the light switch is not sufficient to prevent electrical shock.

NOTE:

To re-lamp, replacement parts or additional information, contact or visit manufacturer at www.lightandgreen.com.

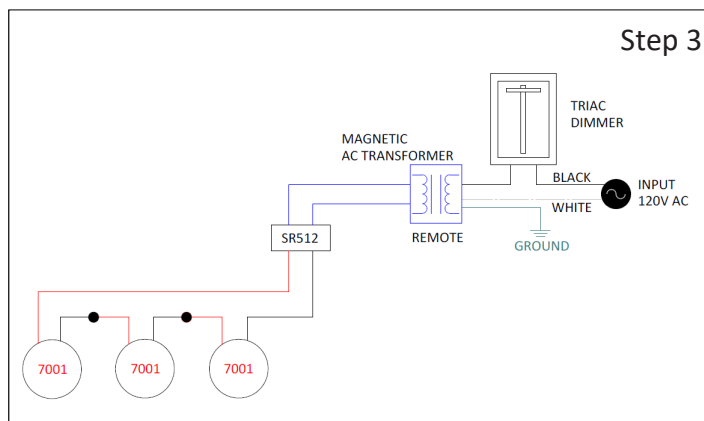

Step 3 - Install Remote Transformer & Led Driver:

- Wire transformer to 120v per above diagram
- SR512 Carries a load for 1 to 3 fixtures
- Wire Led driver to Transformer, if more than 1 "7001" wire per diagram
- Pull Led leads through aperture of fixture.

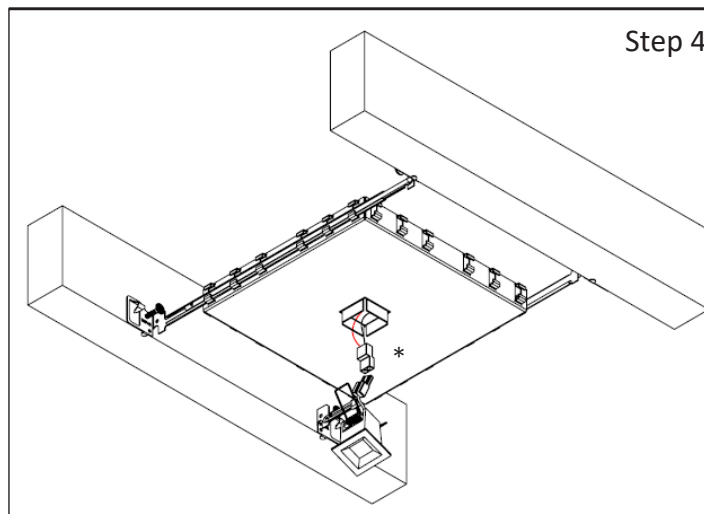

Step 4 - Test Led Trim fixture

- After pulling Led lead.
- "*" Indicates the (Quick Connector) come with the led and must be connected to driver; (red wire to red wire & black wire to black wire)
- Connect the LED Light and turn Switch On to make sure it lights.
- Disconnect the Led Trim and save until STEP 9.

INSTALLATION INSTRUCTIONS

PREPARING THE LUMINAIRE

NARROW RECESSED DOWN LIGHT:
Model:7001 - 1X1 NARROWLINE TRIMMED SQUARE DOWNLIGHT

SAVE THESE INSTRUCTIONS

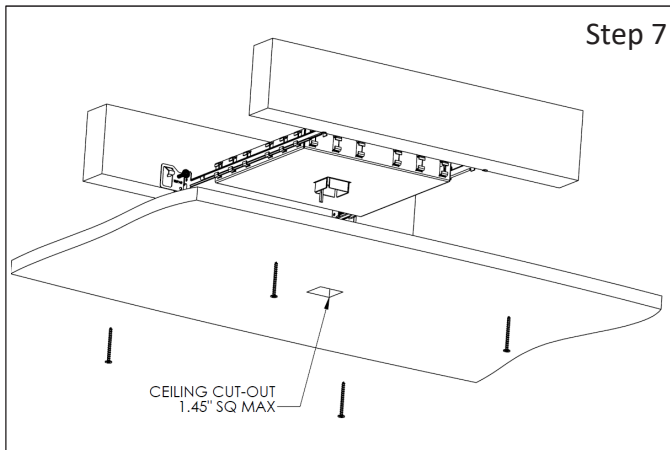

Step 7 - Cut-Out Dry-wall and Install to Ceiling Joist:

- Mark the Fixture location on Dry-wall "Sheet" and cut-out.
- Align the Cut-out with Fixture and secure drywall
- Make sure that the fixture is flush & DOES NOT PROTRUDE drywall.

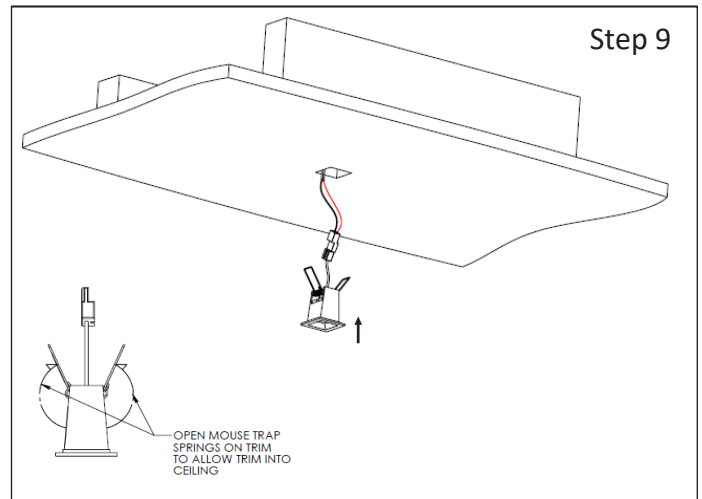

Step 9 - Connect & Insert Trim

- Connect Led trim to leads.
- Open mouse trap springs and insert trim in ceiling/ plaster frame

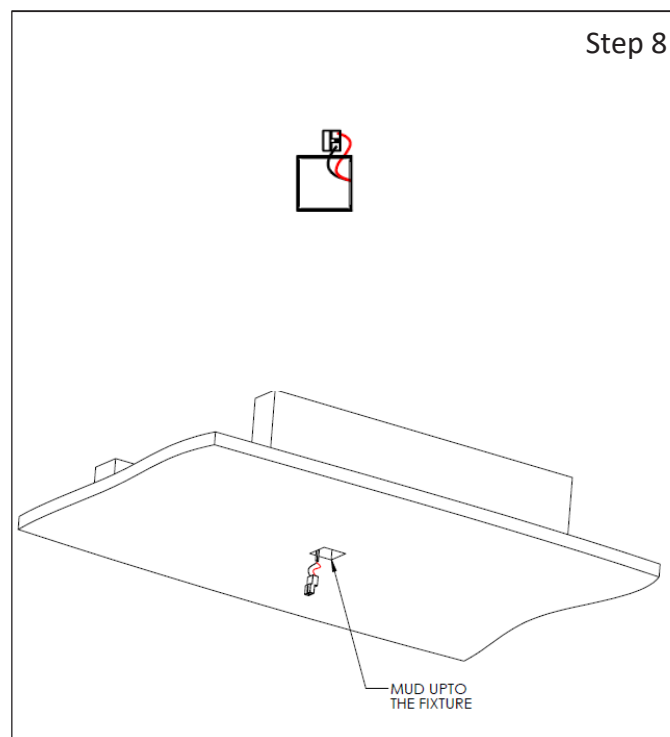

Step 8 - Plastering Ceiling Cut-Out with fixture & Paint:

- Mud up to the fixture and paint.
- Make sure no crack or flaws are visible

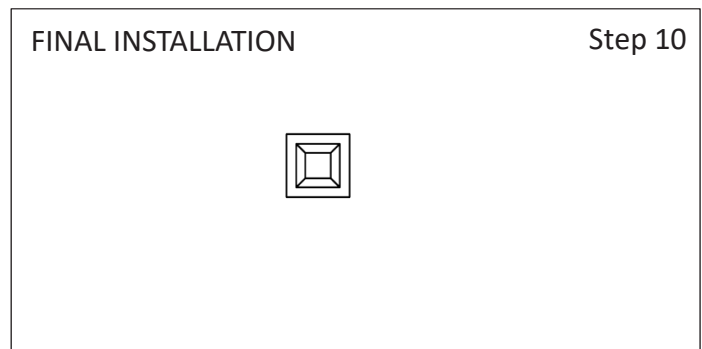

Step 10 FINALIZE INSTALLATION :

- Test Fixture to confirm it operates properly