

Indoor Luminaire Photometric Data

Description Information

Luminaire Name: LED Recessed Downlight		Lum. Catalog: LG-9023A-AC-30K	Test ID: IESNA:LM-79-08
Lamp Name:		Lamp Catalog: LED	Test Date: 2/16/2021
Manufacture: Light and Green		Shld. Ang(°):	Test Machine:GON-2000
Test Lab: LIGHT LABORATORY, INC. (www.lightlaboratory.com)		Frequency (Hz):	Lamp CCT(K): Ra:
Lum. Size (W*L*H):0.250m*0.250m*0.000m		Lum. Area (m2):0.063	Lum. W(kg): 0.000
Test System: C, γ	Test Step: C=5.0 γ=1.0	Temp. (°C): 25	Humidity(%):

Character Parameter

Lamp Speciality Parameter		Luminaire Speciality Parameter	
Rated Flux(lm): 2577.508	Luminaire Flux(lm): 2577.508	Field Angle(10%Imax): 79.3(°)	
Rated Power(W):	Luminaire Efficiency: 100.00%	Down Lumens&Percent: 2577.508lm 100.00%	
Rated Voltage(V):	Luminaire EER(lm/W): 76.235	Up Lumens&Percent: 0.000lm 0.00%	
Tested Power(W): 33.810	Max. Candela(cd): 4092.000	S/MH: C0_a180=0.616 C90_270=0.637	
Lamps' Inside: 1	Max Cand@Ang. (°): C=85.0 γ=1.0	CIE Type: Semi-Direct	
Tested Electrics (V, A, pf):239.6, 0.056, 0.967	Beam Angle(50%Imax): 40.5(°)	ErP φ use(90°): 2308.572lm	
Lamp Size (W*L*H):0.250m*0.250m*0.000m	Left=-20.2°, Right=20.2°	IRF(%): 357.488	

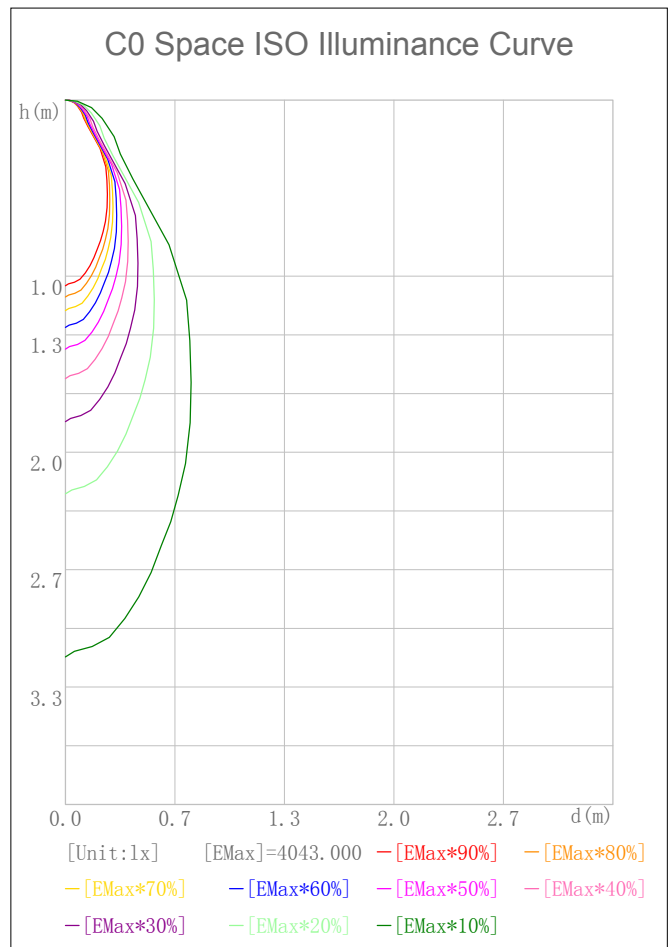
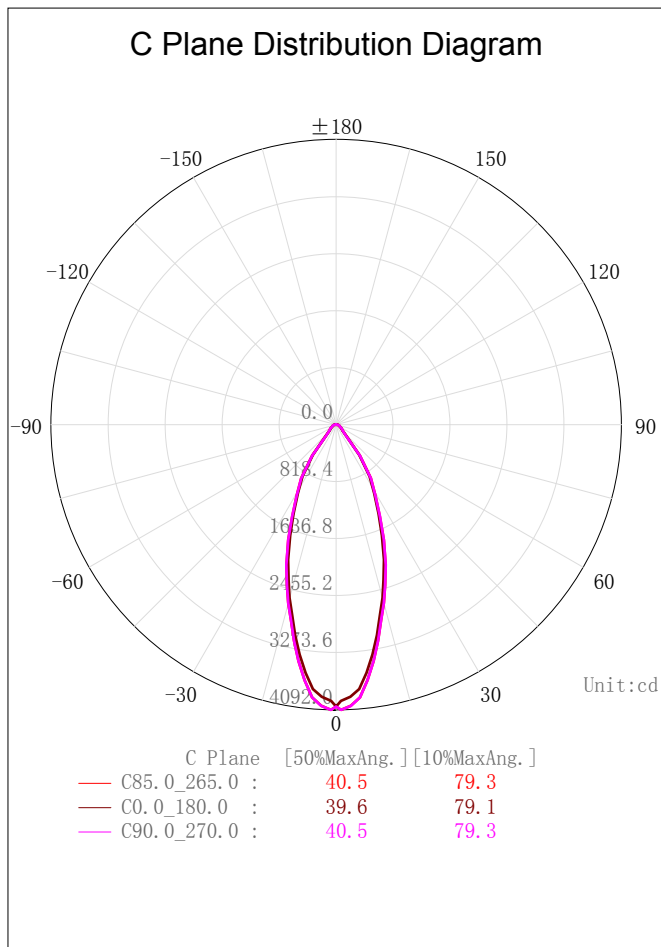

2D Plane Light Intensity Distribution Curve

Lum. Name: LED Recessed Downlight	Lum. Catalog: LG-9023A-AC-30K	Test ID: IESNA:LM-79-08
Lamp Name:	Lamp Catalog: LED	Test Lab: LIGHT LABORATORY, INC. (www.lig
Manufacture: Light and Green	Test Machine:GON-2000	Test Date: 2/16/2021

C Plane Distribution Diagram

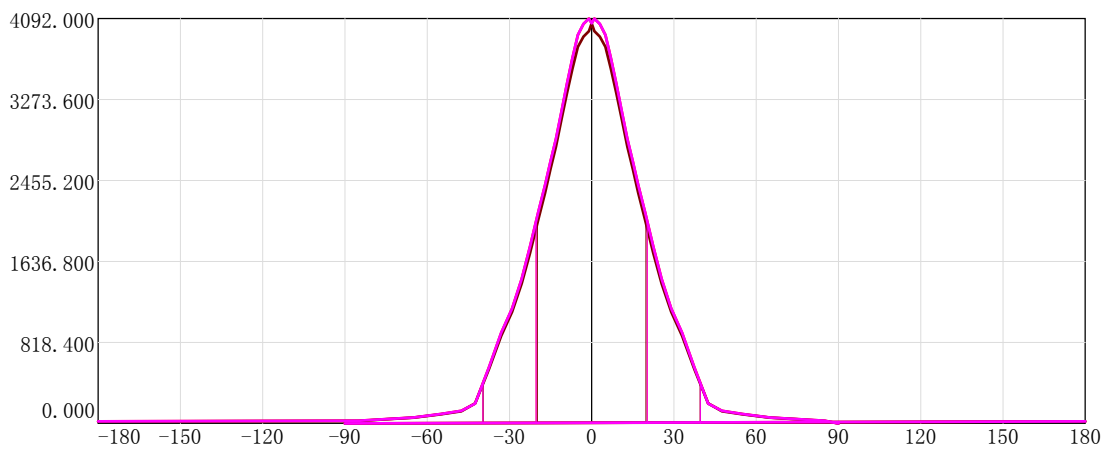
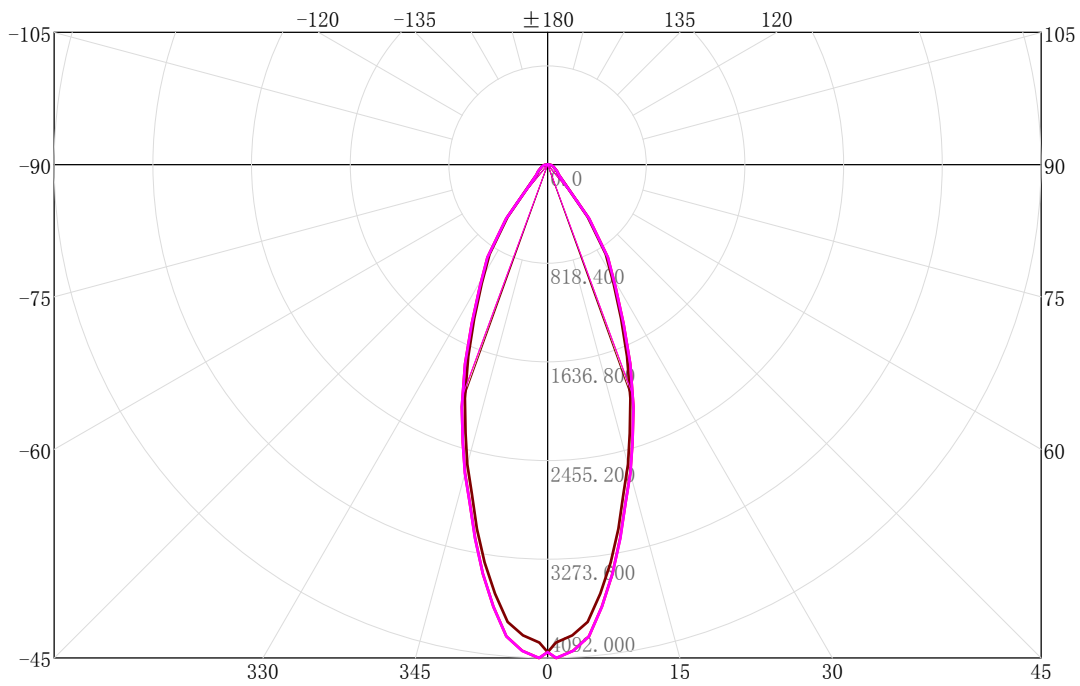

C Plane	[50%MaxAng.]	[10%MaxAng.]	Unit:cd
C85.0_265.0	40.5	79.3	
C0.0_180.0	39.6	79.1	
C90.0_270.0	40.5	79.3	

3D Light Intensity Distribution Modal

Lum. Name: LED Recessed Downlight	Lum. Catalog: LG-9023A-AC-30K	Test ID: IESNA:LM-79-08
Lamp Name:	Lamp Catalog: LED	Test Lab: LIGHT LABORATORY, INC. (www.lig
Manufacture: Light and Green	Test Machine:GON-2000	Test Date: 2/16/2021

3D Light Intensity Distribution Modal

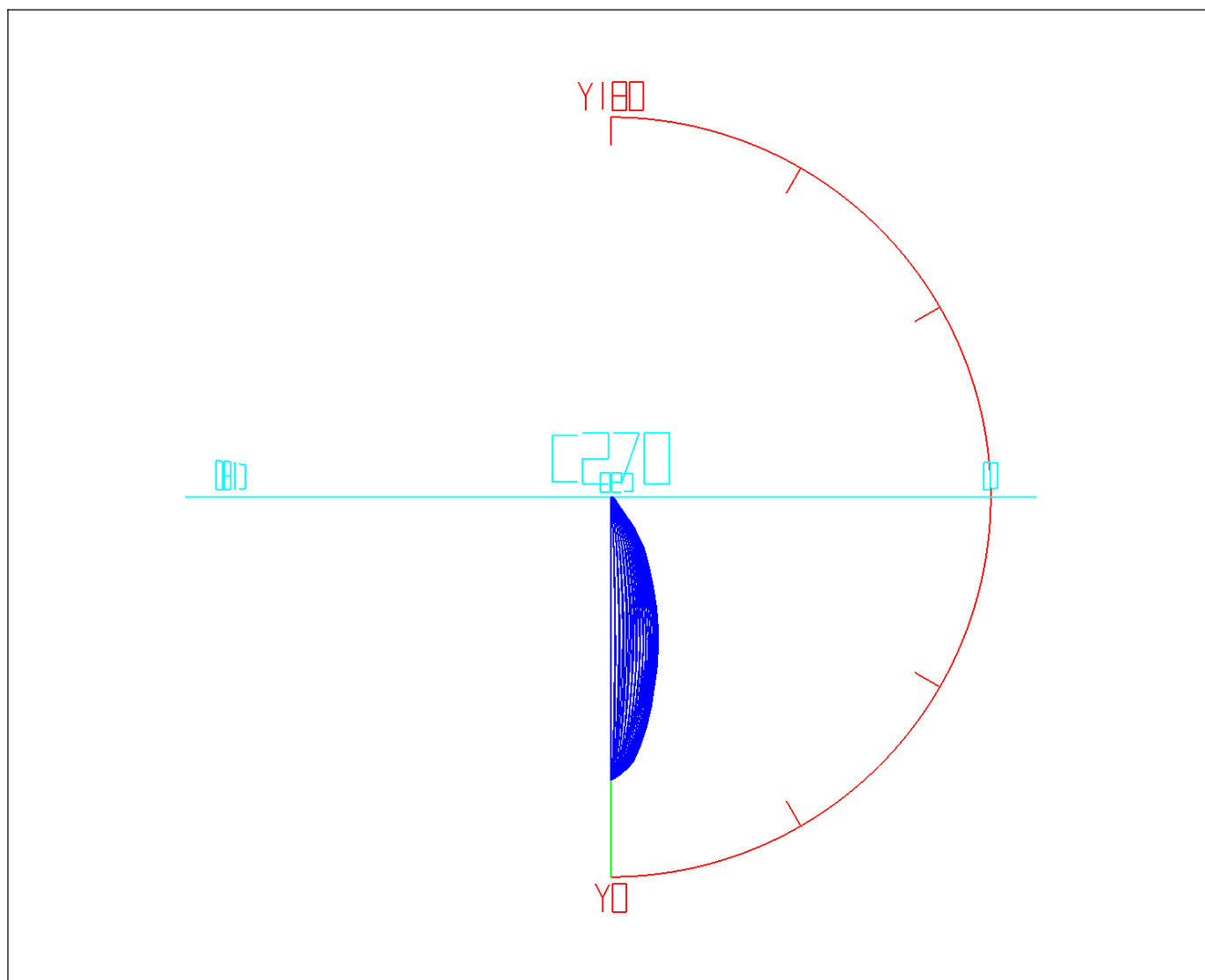

Curves: 3D Model ——— Fixture ——— Vert. HUD ——— Hori. HUD ———
 View Angles: Orient:0 Tilt:0 Roll:0 Spin:0

Zonal Flux Tabulation

Zone (γ)	Zone Flux (lm)	Sums Flux (lm)	Zone%Lamp	Sums%Lamp
0.0-1.0	3.87	3.87	0.15	0.15
1.0-3.0	30.67	34.54	1.19	1.34
3.0-5.0	60.08	94.61	2.33	3.67
5.0-7.0	86.17	180.78	3.34	7.01
7.0-9.0	107.34	288.12	4.16	11.18
9.0-11.0	123.94	412.05	4.81	15.99
11.0-13.0	135.83	547.89	5.27	21.26
13.0-15.0	144.56	692.45	5.61	26.87
15.0-17.0	150.51	842.96	5.84	32.70
17.0-19.5	191.50	1034.47	7.43	40.13
19.5-22.5	226.79	1261.26	8.80	48.93
22.5-25.5	213.62	1474.88	8.29	57.22
25.5-29.0	226.95	1701.83	8.81	66.03
29.0-33.0	231.05	1932.88	8.96	74.99
33.0-37.5	207.28	2140.15	8.04	83.03
37.5-42.5	133.58	2273.74	5.18	88.21
42.5-47.5	63.76	2337.50	2.47	90.69
47.5-55.0	70.53	2408.04	2.74	93.42
55.0-65.0	72.72	2480.75	2.82	96.25
65.0-75.0	52.57	2533.33	2.04	98.29
75.0-85.0	37.09	2570.42	1.44	99.72
85.0-90.0	7.09	2577.51	0.28	100.00

Rectangle ISO Lighting Intensity Diagram

Lum. Name: LED Recessed Downlight	Lum. Catalog: LG-9023A-AC-30K	Test ID: IESNA:LM-79-08
Lamp Name:	Lamp Catalog: LED	Test Lab: LIGHT LABORATORY, INC. (www.lig
Manufacture: Light and Green	Test Machine:GON-2000	Test Date: 2/16/2021

ISO Lighting Intensity Curve

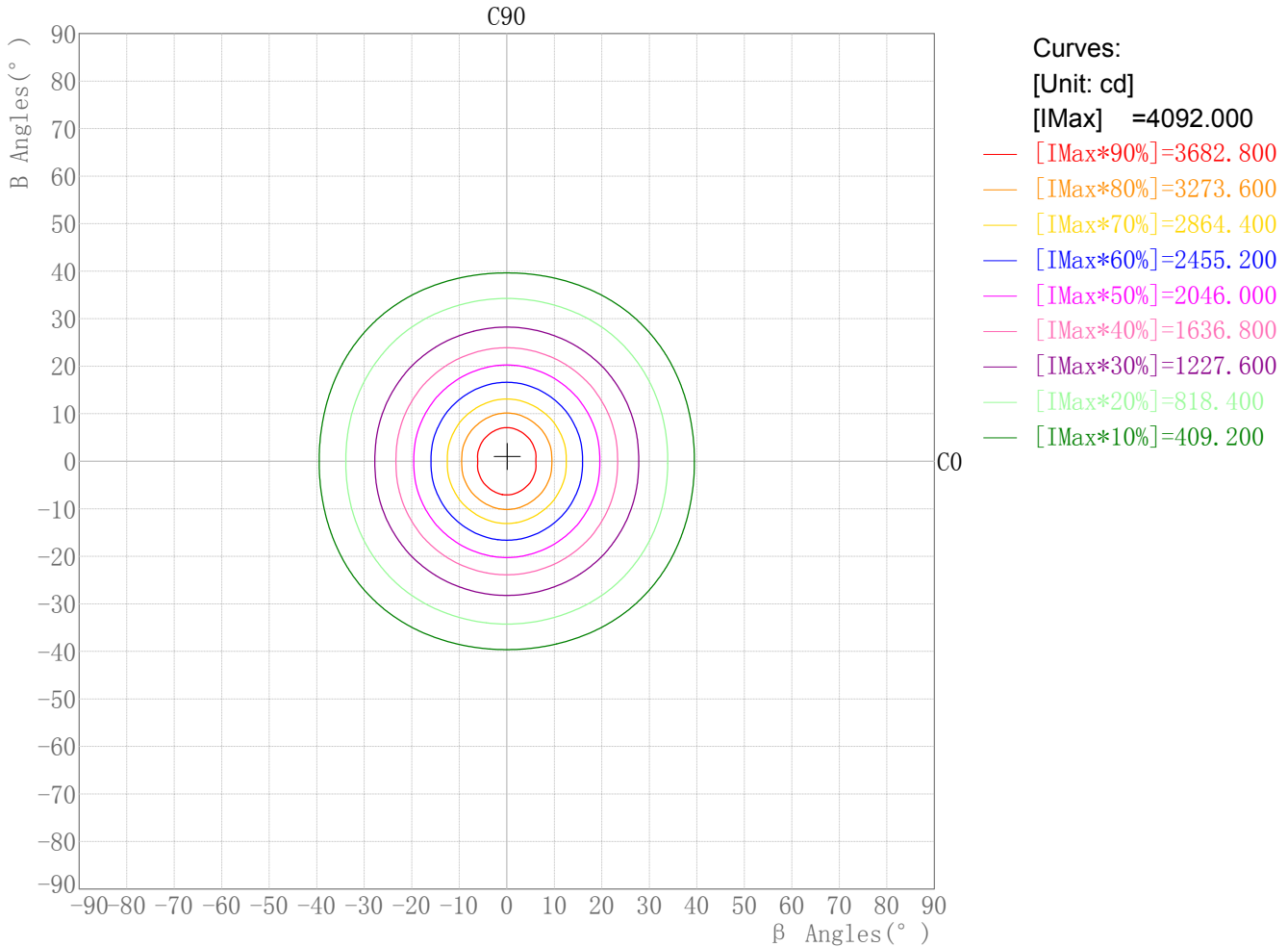

Maximum Light Intensity(cd): 4092.00
 Maximum Cand.@Angle: H=0.1°,V=1.0°

Plane ISO-Illuminance Diagram

Lum. Name: LED Recessed Downlight	Lum. Catalog: LG-9023A-AC-30K	Test ID: IESNA:LM-79-08
Lamp Name:	Lamp Catalog: LED	Test Lab: LIGHT LABORATORY, INC. (www.lig
Manufacture: Light and Green	Test Machine:GON-2000	Test Date: 2/16/2021

Plane ISO-Illuminance Curve

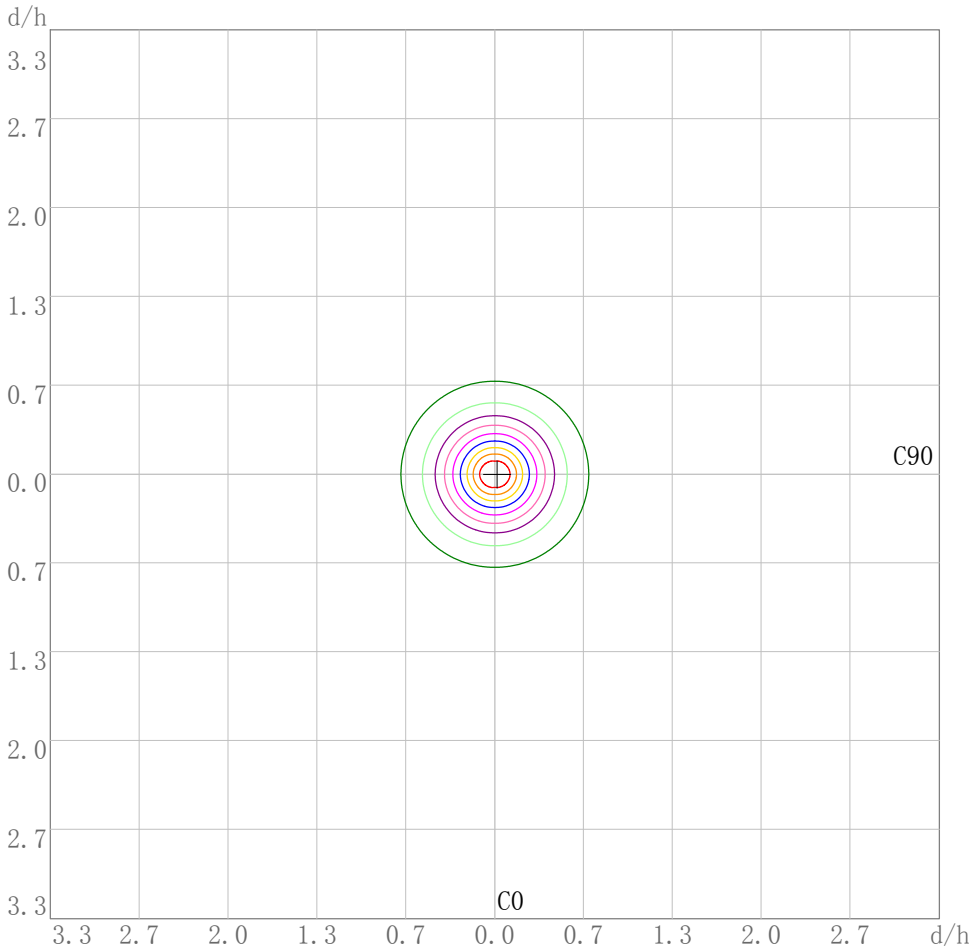

- Curves:
unit:lx
- [EMax] =454.459
 - [EMax*90%]=409.013
 - [EMax*80%]=363.567
 - [EMax*70%]=318.121
 - [EMax*60%]=272.675
 - [EMax*50%]=227.229
 - [EMax*40%]=181.784
 - [EMax*30%]=136.338
 - [EMax*20%]=90.892
 - [EMax*10%]=45.446

Working Plane Luminaire Mounting Height(m): 3.00
 Working Plane Maximum Illuminance(lx): 454.46
 Working Plane Maximum Illuminance Position(d/h):H0.0 V0.0

3D Plane ISO Illuminance Diagram

Lum. Name: LED Recessed Downlight	Lum. Catalog: LG-9023A-AC-30K	Test ID: IESNA:LM-79-08
Lamp Name:	Lamp Catalog: LED	Test Lab: LIGHT LABORATORY, INC. (www.lig
Manufacture: Light and Green	Test Machine:GON-2000	Test Date: 2/16/2021

3D Plane Illuminance Modal

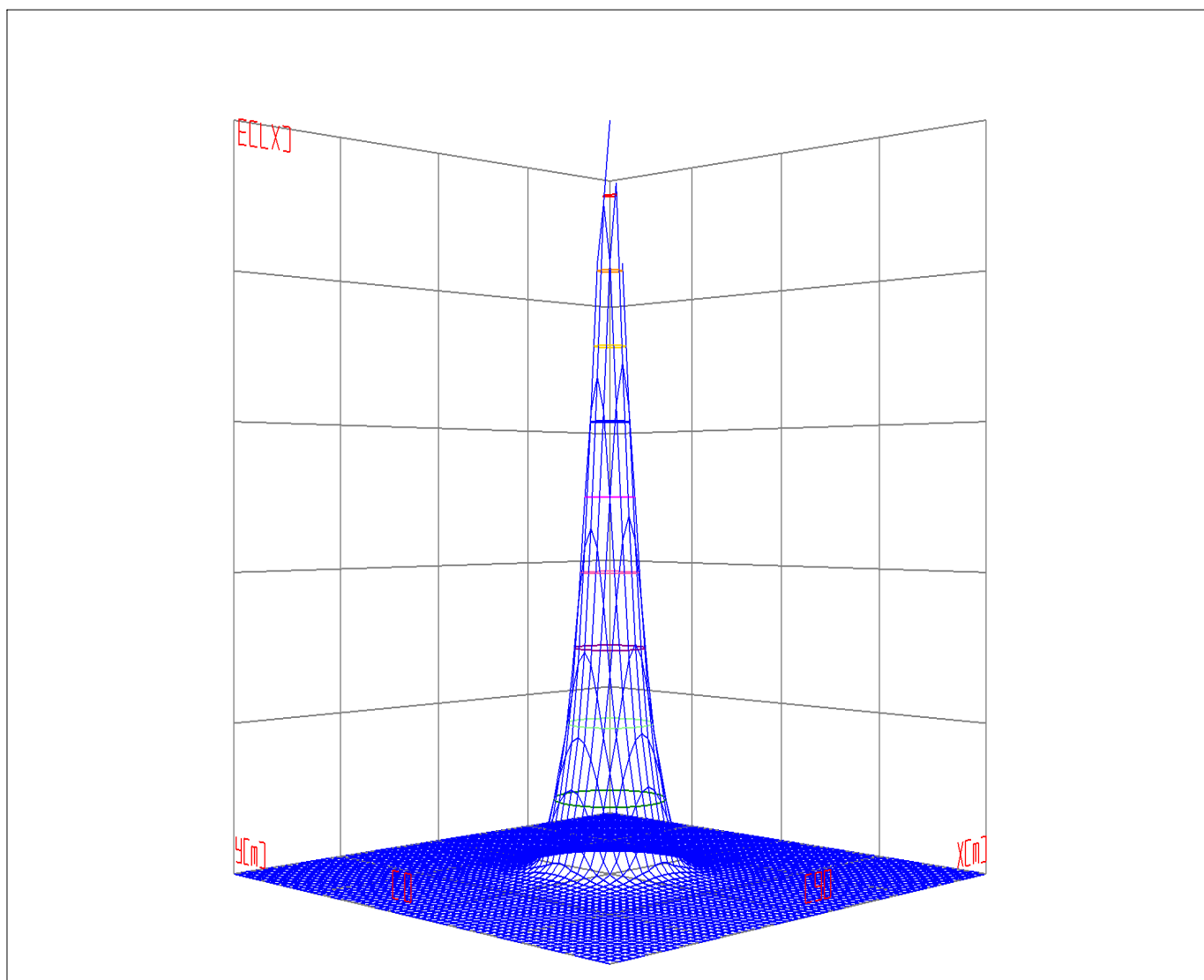

Curves: 3D Model — 90% — 80% — 70% — 60% — 50% — 40% — 30% — 20% — 10% —
 View Angles(deg): 0 Height(m): 3.0 Distance(m): 10.0

Space ISO Illuminance Diagram

Lum. Name: LED Recessed Downlight	Lum. Catalog: LG-9023A-AC-30K	Test ID: IESNA:LM-79-08
Lamp Name:	Lamp Catalog: LED	Test Lab: LIGHT LABORATORY, INC. (www.lig
Manufacture: Light and Green	Test Machine:GON-2000	Test Date: 2/16/2021

Space ISO Illuminance Curve

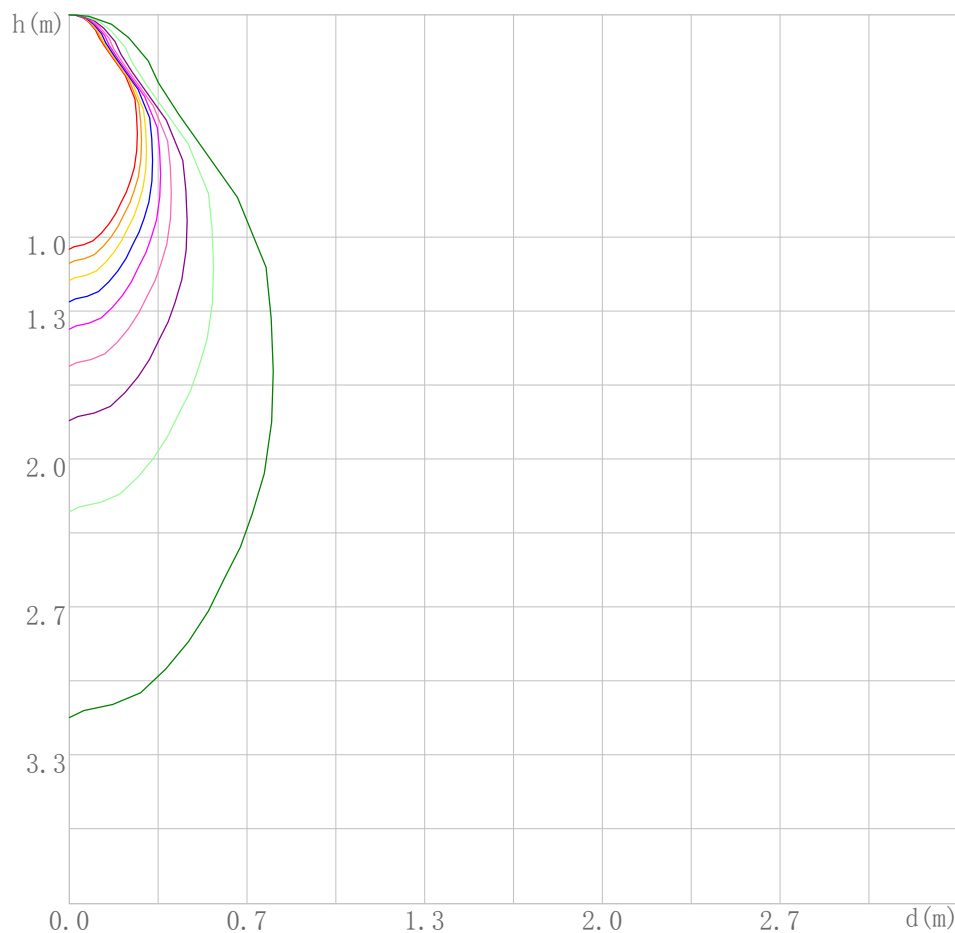

- Curves:
 [Unit: lx]
 [EMax] =4043.000
- [EMax*90%]=3638.700
 - [EMax*80%]=3234.400
 - [EMax*70%]=2830.100
 - [EMax*60%]=2425.800
 - [EMax*50%]=2021.500
 - [EMax*40%]=1617.200
 - [EMax*30%]=1212.900
 - [EMax*20%]=808.600
 - [EMax*10%]=404.300

Space Plane Maximum Illuminance and @Angle:4043.00lx,0.0deg
 Plane Maximum Lighting Intensity and @Angle:4043.000cd,0deg

Illuminance-Distance Diagram

Lum. Name: LED Recessed Downlight	Lum. Catalog: LG-9023A-AC-30K	Test ID: IESNA:LM-79-08
Lamp Name:	Lamp Catalog: LED	Test Lab: LIGHT LABORATORY, INC. (www.lig
Manufacture: Light and Green	Test Machine:GON-2000	Test Date: 2/16/2021

Illuminance-Distance Curve

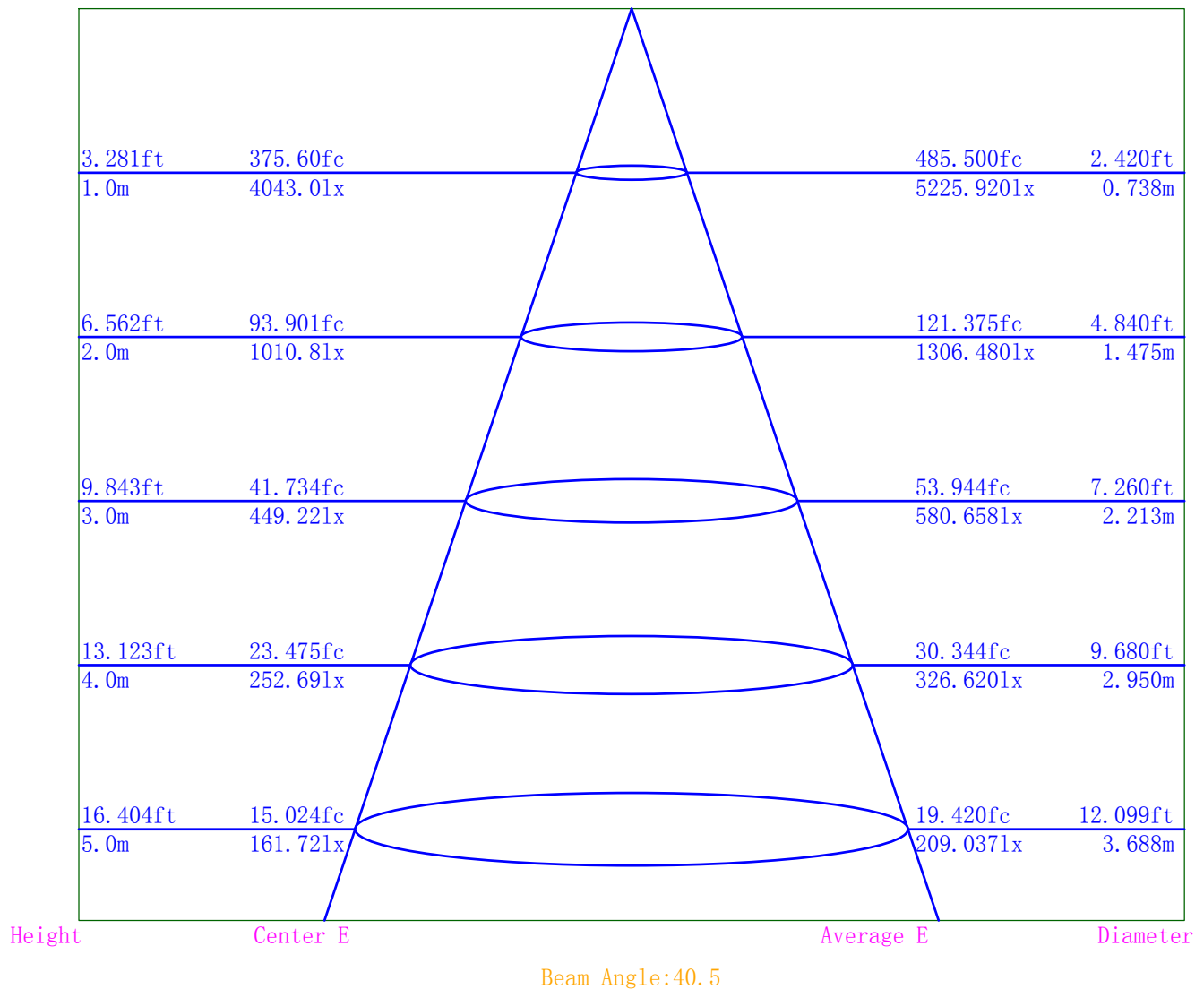

Indoor Luminance Limiting Curves

Lum. Name: LED Recessed Downlight	Lum. Catalog: LG-9023A-AC-30K	Test ID: IESNA:LM-79-08
Lamp Name:	Lamp Catalog: LED	Test Lab: LIGHT LABORATORY, INC. (www.lig
Manufacture: Light and Green	Test Machine:GON-2000	Test Date: 2/16/2021

Glare Grade Table

GI	Quality	Using Illuminance							
		a	b	c	d	e	f	g	h
1.15	A	2000	1000	500	<=300				
1.5	B		2000	1000	500	<=300			
1.85	C			2000	1000	500	<=300		
2.2	D				2000	1000	500	<=300	
2.55	E	a				2000	1000	500	<=300
			b	c	d	e	f	g	h

Luminance Table

Gama (deg)	45	50	55	60	65	70	75	80	85
C0	3677	2804	2566	2400	2196	2339	2596	3087	4589
C90	3711	2921	2678	2496	2272	2433	2720	3271	4957

Luminance Limiting Curve

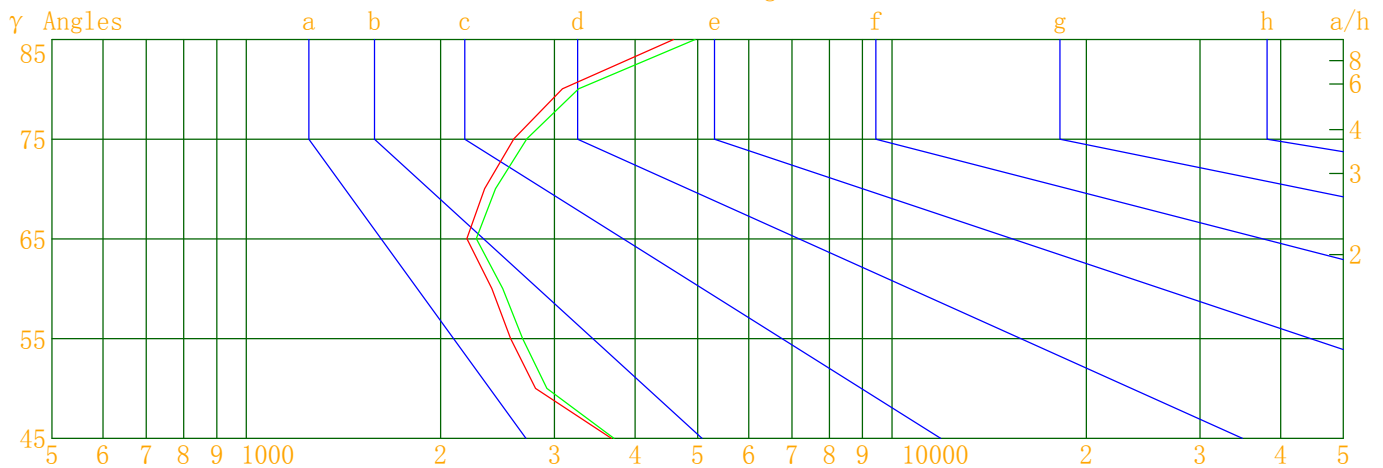

Luminous Size: Length(m)=0.250 Width(m)=0.250 Height(m)=0.000 Area(m^2)=0.062500
 Luminous Type: Without Luminous Side
 Luminous Curves: C0-C180 Color: — C90-C270 Color: —

Indoor Budgetary Estimate Table

Lum. Name: LED Recessed Downlight	Lum. Catalog: LG-9023A-AC-30K	Test ID: IESNA:LM-79-08
Lamp Name:	Lamp Catalog: LED	Test Lab: LIGHT LABORATORY, INC. (www.lig
Manufacture: Light and Green	Test Machine:GON-2000	Test Date: 2/16/2021

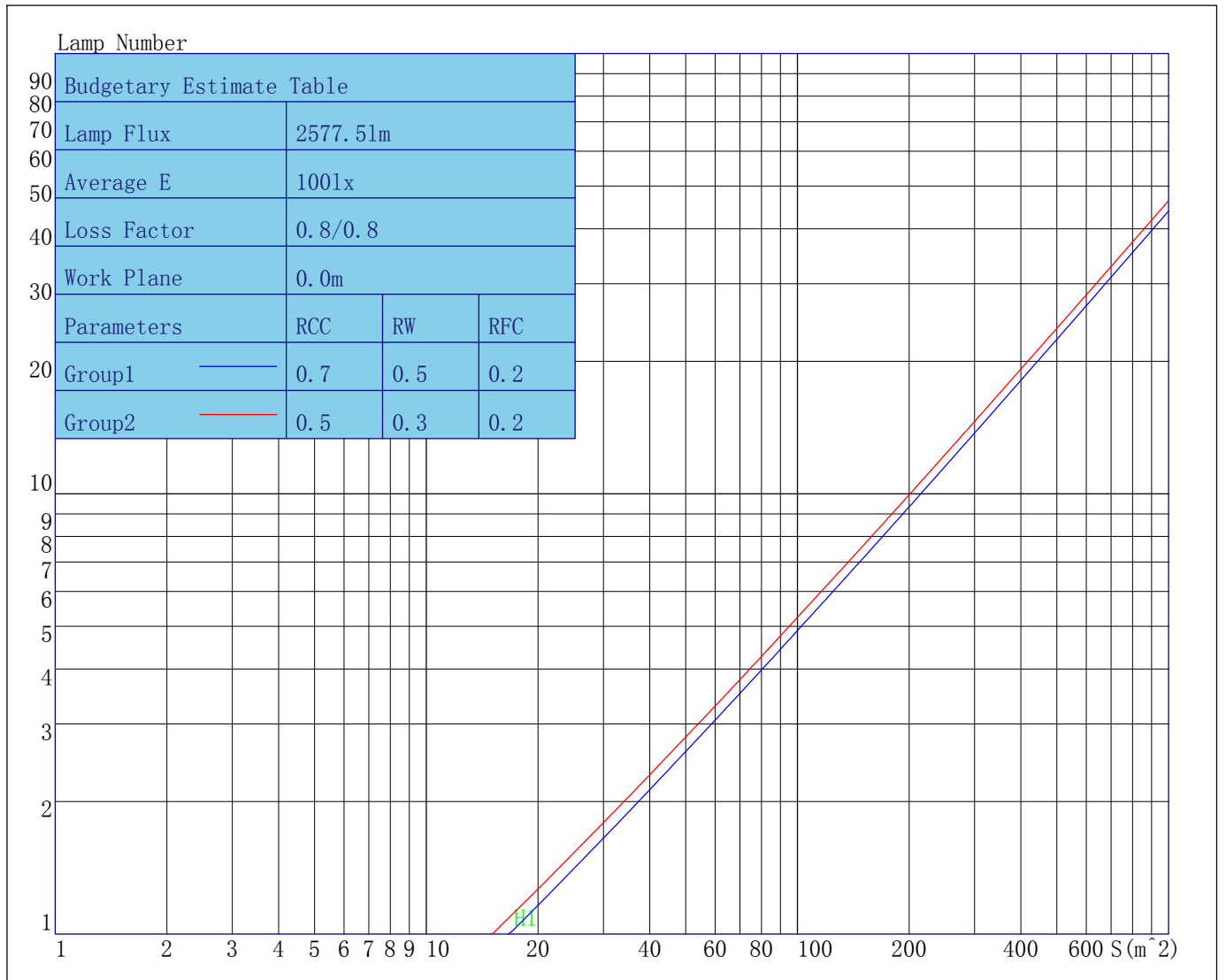

Parameters1: Rhocc = 0.7 Rhow = 0.5 Rhofc = 0.2 LLF = 0.8
 Parameters2: Rhocc = 0.5 Rhow = 0.3 Rhofc = 0.2 LLF = 0.8
 Average Illuminance(lx): 100 Cavity Height: H1(m) = 2

Indoor Coefficient of Utilization Table

Lum. Name: LED Recessed Downlight	Lum. Catalog: LG-9023A-AC-30K	Test ID: IESNA:LM-79-08
Lamp Name:	Lamp Catalog: LED	Test Lab: LIGHT LABORATORY, INC. (www.lig
Manufacture: Light and Green	Test Machine:GON-2000	Test Date: 2/16/2021

Coefficients of Utilization - Zonal Cavity Method																					
Coef.	Effective Floor Cavity Reflectance RFC=0.20																				
RhoCC (%)	80				70				50				30				10				0
RhoW (%)	70	50	30	10	70	50	30	10	50	30	10	50	30	10	50	30	10	50	30	10	0
RCR	Coefficient of Utilization (%)																				
0	119	119	119	119	116	116	116	116	111	111	111	106	106	106	102	102	102	100			
1	113	110	107	104	110	107	105	103	103	101	99	100	98	96	96	95	94	92			
2	107	101	97	93	104	100	96	92	96	93	90	93	91	88	90	88	86	85			
3	101	94	89	85	99	93	88	84	90	86	82	88	84	81	85	82	80	78			
4	96	88	82	77	94	87	81	77	84	80	76	82	78	75	80	77	74	73			
5	91	82	76	72	89	81	76	71	79	74	71	78	73	70	76	72	69	68			
6	86	77	71	67	85	76	71	66	75	70	66	73	69	65	72	68	65	64			
7	82	73	67	62	81	72	66	62	71	66	62	70	65	61	68	64	61	60			
8	78	69	63	59	77	68	62	58	67	62	58	66	61	58	65	61	58	56			
9	75	65	59	55	74	65	59	55	64	59	55	63	58	55	62	58	54	53			
10	72	62	56	52	71	61	56	52	61	55	52	60	55	52	59	55	52	50			

Unified Glare Rating Table

Lum. Name: LED Recessed Downlight	Lum. Catalog: LG-9023A-AC-30K	Test ID: IESNA:LM-79-08
Lamp Name:	Lamp Catalog: LED	Test Lab: LIGHT LABORATORY, INC. (www.lig
Manufacture: Light and Green	Test Machine:GON-2000	Test Date: 2/16/2021

Unified Glare Rating Table

Ceiling RCC	0.70	0.70	0.50	0.50	0.30	0.70	0.70	0.50	0.50	0.30
Wall RW	0.50	0.30	0.50	0.30	0.30	0.50	0.30	0.50	0.30	0.30
Floor RFC	0.20	0.20	0.20	0.20	0.20	0.20	0.20	0.20	0.20	0.20
Room Size	Vewed crosswise					Vewed endwise				
X=2H Y=2H	13.8	14.9	14.2	15.2	15.5	13.9	15.0	14.3	15.3	15.7
Y=3H	14.4	15.4	14.8	15.7	16.1	14.6	15.6	15.0	15.9	16.3
Y=4H	14.9	15.8	15.3	16.1	16.5	15.1	16.0	15.5	16.3	16.7
Y=6H	15.4	16.3	15.9	16.6	17.0	15.7	16.5	16.1	16.9	17.3
Y=8H	15.8	16.5	16.2	16.9	17.3	16.0	16.8	16.4	17.2	17.6
Y=12H	16.1	16.8	16.5	17.2	17.7	16.4	17.1	16.8	17.5	17.9
X=4H Y=2H	13.9	14.8	14.3	15.2	15.5	14.0	14.9	14.4	15.3	15.7
Y=3H	14.8	15.6	15.2	16.0	16.4	15.0	15.7	15.4	16.1	16.5
Y=4H	15.5	16.1	15.9	16.5	17.0	15.6	16.3	16.1	16.7	17.2
Y=6H	16.2	16.8	16.7	17.3	17.7	16.5	17.0	16.9	17.5	17.9
Y=8H	16.7	17.2	17.1	17.6	18.1	16.9	17.4	17.4	17.9	18.4
Y=12H	17.2	17.6	17.6	18.1	18.6	17.4	17.9	17.9	18.4	18.9
X=8H Y=4H	15.7	16.3	16.2	16.7	17.2	15.9	16.4	16.3	16.8	17.3
Y=6H	16.7	17.2	17.2	17.7	18.2	16.9	17.3	17.4	17.8	18.4
Y=8H	17.3	17.7	17.8	18.2	18.7	17.5	17.9	18.1	18.4	18.9
Y=12H	18.0	18.3	18.5	18.8	19.4	18.3	18.6	18.8	19.1	19.7
X=12H Y=4H	15.8	16.2	16.3	16.7	17.2	15.9	16.4	16.4	16.9	17.3
Y=6H	16.9	17.2	17.4	17.7	18.3	17.0	17.4	17.6	17.9	18.4
Y=8H	17.5	17.9	18.1	18.4	18.9	17.7	18.1	18.3	18.6	19.1
Variations with the objerver position at spacings										
S=1.0H	0.2/-0.2					0.2/-0.2				
S=1.5H	0.3/-0.3					0.3/-0.3				
S=2.0H	0.2/-0.3					0.2/-0.3				
Reduced UGR Table:										
Nordic Standard Table:	BKO					BKO				
Correction Value	2.8					2.9				

to the CIE Pub.117, data has been corrected, refers to the lamp's lumens 8.2flm.

Candela Tabulation

V/H	C0.0	C5.0	C10.0	C15.0	C20.0	C25.0	C30.0	C35.0	C40.0	C45.0	C50.0	C55.0
γ 0.0	4043.00	4043.00	4043.00	4043.00	4043.00	4043.00	4043.00	4043.00	4043.00	4043.00	4043.00	4043.00
γ 1.0	3964.00	3968.00	3980.00	3992.00	3997.00	4002.00	4008.00	4016.00	4028.00	4036.00	4044.00	4052.00
γ 3.0	3909.00	3914.00	3924.00	3937.00	3943.00	3946.00	3953.00	3963.00	3975.00	3982.00	3990.00	3997.00
γ 5.0	3806.00	3810.00	3823.00	3835.00	3840.00	3845.00	3851.00	3861.00	3871.00	3877.00	3883.00	3888.00
γ 7.0	3584.00	3588.00	3598.00	3609.00	3614.00	3617.00	3623.00	3631.00	3641.00	3646.00	3650.00	3654.00
γ 9.0	3339.00	3342.00	3348.00	3359.00	3364.00	3367.00	3373.00	3380.00	3389.00	3390.00	3396.00	3398.00
γ 11.0	3076.00	3080.00	3086.00	3095.00	3098.00	3100.00	3105.00	3112.00	3120.00	3120.00	3123.00	3124.00
γ 13.0	2797.00	2803.00	2809.00	2817.00	2820.00	2822.00	2824.00	2830.00	2838.00	2839.00	2841.00	2844.00
γ 15.0	2572.00	2573.00	2581.00	2588.00	2589.00	2593.00	2596.00	2601.00	2609.00	2609.00	2612.00	2616.00
γ 17.0	2329.00	2331.00	2337.00	2343.00	2346.00	2349.00	2351.00	2357.00	2366.00	2367.00	2372.00	2376.00
γ 19.5	2056.00	2056.00	2064.00	2069.00	2072.00	2075.00	2077.00	2080.00	2088.00	2090.00	2093.00	2098.00
γ 22.5	1721.00	1725.00	1730.00	1734.00	1737.00	1740.00	1741.00	1744.00	1753.00	1753.00	1758.00	1760.00
γ 25.5	1414.00	1416.00	1422.00	1425.00	1427.00	1428.00	1428.00	1430.00	1437.00	1437.00	1439.00	1441.00
γ 29.0	1127.00	1129.00	1133.00	1135.00	1137.00	1138.00	1139.00	1140.00	1144.00	1146.00	1147.00	1148.00
γ 33.0	884.00	886.00	889.00	891.00	892.00	894.00	895.00	895.00	898.00	901.00	903.00	903.00
γ 37.5	546.00	547.00	548.00	550.00	550.00	551.00	552.00	552.00	553.00	555.00	557.00	558.00
γ 42.5	202.00	202.00	202.00	203.00	203.00	203.00	204.00	203.00	203.00	203.00	203.00	203.00
γ 47.5	123.00	123.00	124.00	124.00	125.00	125.00	125.00	125.00	126.00	126.00	126.00	127.00
γ 55.0	92.00	92.00	92.00	93.00	93.00	93.00	93.00	94.00	94.00	94.00	94.00	95.00
γ 65.0	58.00	58.00	58.00	58.00	59.00	59.00	59.00	59.00	59.00	59.00	60.00	60.00
γ 75.0	42.00	42.00	42.00	42.00	42.00	42.00	43.00	43.00	43.00	43.00	43.00	43.00
γ 85.0	25.00	25.00	25.00	25.00	25.00	25.00	25.00	26.00	26.00	26.00	26.00	26.00
γ 90.0	0.00	0.00	0.00	0.00	0.00	0.00	0.00	0.00	0.00	0.00	0.00	0.00
V/H	C60.0	C65.0	C70.0	C75.0	C80.0	C85.0	C90.0					
γ 0.0	4043.00	4043.00	4043.00	4043.00	4043.00	4043.00	4043.00					
γ 1.0	4062.00	4070.00	4077.00	4085.00	4090.00	4092.00	4091.00					
γ 3.0	4005.00	4015.00	4020.00	4029.00	4036.00	4037.00	4038.00					
γ 5.0	3896.00	3904.00	3910.00	3918.00	3924.00	3926.00	3927.00					
γ 7.0	3664.00	3671.00	3675.00	3684.00	3690.00	3692.00	3693.00					
γ 9.0	3406.00	3412.00	3416.00	3424.00	3430.00	3433.00	3433.00					
γ 11.0	3131.00	3137.00	3141.00	3148.00	3154.00	3154.00	3157.00					
γ 13.0	2851.00	2855.00	2858.00	2865.00	2871.00	2874.00	2876.00					
γ 15.0	2623.00	2629.00	2632.00	2638.00	2644.00	2648.00	2650.00					
γ 17.0	2382.00	2389.00	2393.00	2399.00	2407.00	2408.00	2408.00					
γ 19.5	2104.00	2111.00	2114.00	2120.00	2128.00	2131.00	2133.00					
γ 22.5	1767.00	1771.00	1774.00	1780.00	1784.00	1788.00	1788.00					
γ 25.5	1446.00	1448.00	1450.00	1454.00	1459.00	1460.00	1461.00					
γ 29.0	1151.00	1152.00	1153.00	1157.00	1159.00	1161.00	1161.00					
γ 33.0	907.00	907.00	909.00	911.00	914.00	916.00	917.00					
γ 37.5	559.00	559.00	560.00	562.00	563.00	564.00	564.00					
γ 42.5	205.00	204.00	204.00	203.00	203.00	202.00	200.00					
γ 47.5	127.00	128.00	128.00	128.00	128.00	128.00	128.00					
γ 55.0	95.00	95.00	95.00	95.00	96.00	96.00	96.00					
γ 65.0	60.00	60.00	60.00	60.00	60.00	60.00	60.00					
γ 75.0	43.00	43.00	43.00	44.00	44.00	44.00	44.00					
γ 85.0	26.00	26.00	27.00	27.00	27.00	27.00	27.00					
γ 90.0	0.00	0.00	0.00	0.00	0.00	0.00	0.00					