

LG-9111

3" Non-adjustable Square Recessed Downlight LED- Triple

Project Address:	Project Name:
Fixture Type:	Quantity:

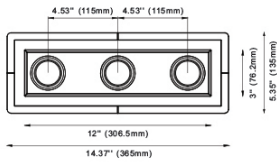

Trim

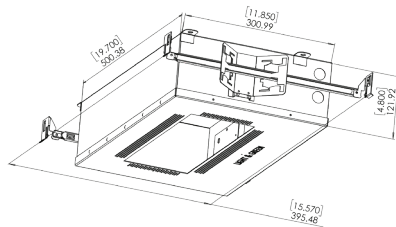

Shallow Housing

HARMONY

The Harmony Trimless Recessed Downlights, made from solid gypsum, provide a seamless, trimless installation with a monolithic design that requires no touch-ups after maintenance. The flangeless fixtures feature a Level 5 plaster finish and are paintable and texturable for a perfect fit with any interior style.

LED Module Features:

- High-performance, low-power LEDs ensure reliability and color consistency.
- Available in 2700K, 3000K, 3500K, and 4000K with a CRI of 95+ for accurate color rendering.
- Warm Dim and Tunable White options offer added design flexibility.

The Harmony Series delivers sleek aesthetics and advanced lighting technology for a modern, flawless finish.

- Flicker free
- Dimming performance with Triac/ELV below 0.01%
- Life Rated for 50,000 hours at 70% lumen maintenance

Quick Info (Ordering guide can be found on page 2)



Application New Construction / Remodeling		
Delivered Lumens 1250 lm (13W) / 1610 lm (18W) - (3000K)		Color Quality 95+ CRI
Color Temperature 2700K 3000K 3500K 4000K	Warm Dim Option 1800K-3000K 940 lm (13W) / 1300 lm (18W)	Beam Spreads 15 ° 24 ° 38 ° (standard) 60 °
Input Voltage 120V / 120-277V		Module Ratings Wet location listed
Trims Gypsum Flangeless (seamless)		
Housing Ratings IC Rated / Air Tight / CCEA		
Dimming <ul style="list-style-type: none"> • TRIAC/ELV (120V only) • 0-10 • DALI 2 • Lutron EcoSystem • DMX dimming, >0.01% for Tunable White 		

LG-9111

3" Non-adjustable Square Recessed Downlight LED- Triple

Project Address:	Project Name:
Fixture Type:	Quantity:

Ordering Guide

Order Number

(*) Required fields

LG-9111 - - - - -
*Housing *W/CCT/LM *Dimming Optional Optional Optional

Example Formula

LG-9111 - S - 13W27K - T - N/A - SF - CO-WH
*Housing *W/CCT/LM *Dimming Beam Spread Lens Optical Lens Holder



Required Options

Trim Page #1 LG-9111		Housing Page #4		Wattage/CCT/Lumens Page #5		Dimming Page #5	
LG-9111	3" Non-Adjustable Square Triple	S	Height 4.85" Shallow (1004/3)	13W27K	13 Watts, 2700K, 1200lm	T	TRIAC/ELV Dimming, >0.01%, compatible with 120V only
				13W30K	13 Watts, 3000K, 1250lm	D	DALI Dimming, >0.01%
				13W35K	13 Watts, 3500K, 1300lm	D2	DALI 2 Dimming, >0.01%
				13W40K	13 Watts, 4000K, 1350lm	ECO	Hi-Lume Premier 0.1% Eco System LED Driver with Soft-on, Fade-to-black dimming tech
				13WD	13 Watts, Warm Dim , 1800K-3000K, 940lm	0-10	0-10V Dimming, >0.01%
				13TW	13 Watts, Tunable Dim , 700K-6500K, 910lm (Compatible with Dual Channel 0-10V & DMX dimming only)	DMX	DMX dimming, >0.01% for Tunable White
				18W27K	18 Watts, 2700K, 1568lm	2-10	Dual Channel 0-10V Dimming for Tunable White
				18W30K	18 Watts, 3000K, 1610lm		
				18W35K	18 Watts, 3500K, 1680lm		
				18W40K	18 Watts, 4000K, 11751lm		
				18WD	18 Watts, Warm Dim , 1800K-3000K, 1300lm (Compatible with shallow housing only)		

*Includes 95+ CRI, 38 degrees beam spread

Optional Optics

Beam Spread Page #3		Lens Optical Page #3		Lens Holder Page #3	
15	15° Ultra Narrow	HBL	Honeycomb Diffuser	CY1-WH	Cylinder 1" White
24	24° Narrow Spot	SF	Soft Focus Lens	CY2-WH	Cylinder 2" White
60	60° Wide Flood	FR	Froster Lens	CY3-WH	Cylinder 3" White
	*38° Flood (Included with every purchase)	LS	Linear Spread Lens	CO-WH	Conical 1" White
		PR	Prismatic Lens	CY1-BL	Cylinder 1" Black
				CY2-BL	Cylinder 2" Black
				CY3-BL	Cylinder 3" Black
				CO-BL	Conical 1" Black

LG-9111

3" Non-adjustable Square
Recessed Downlight LED- Triple

Project Address:	Project Name:
Fixture Type:	Quantity:

Optional Optics

BEAM SPREAD



15°



24°



38°(standard)



60°

LENS OPTICAL



Soft Focus



Frosted



Linear Spread



Prismatic

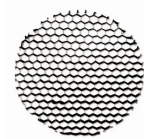

Honeycomb Black

LENS HOLDER

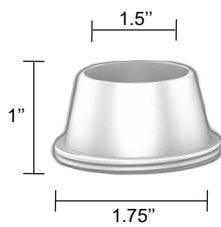

Conical

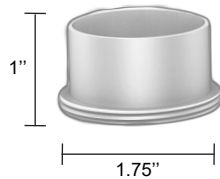

Cylinder 1"

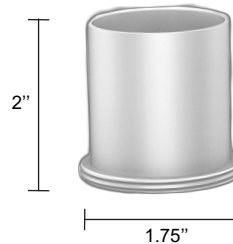

Cylinder 2"

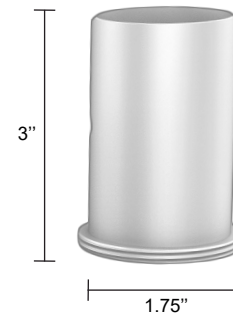

Cylinder 3"



LG-9111

3" Non-adjustable Square Recessed Downlight LED- Triple

1004/3 + A - H3

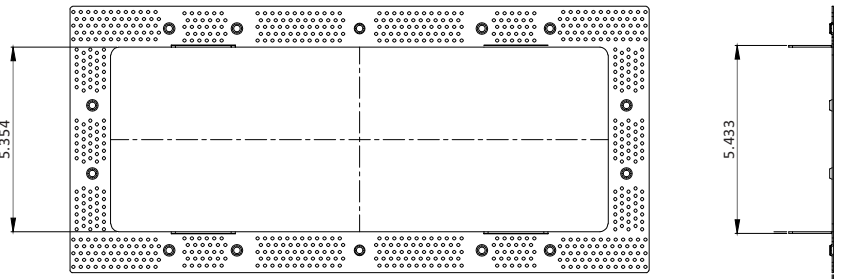
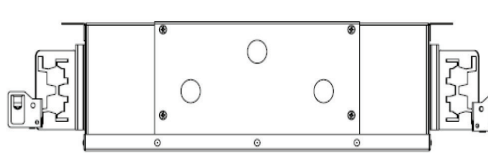
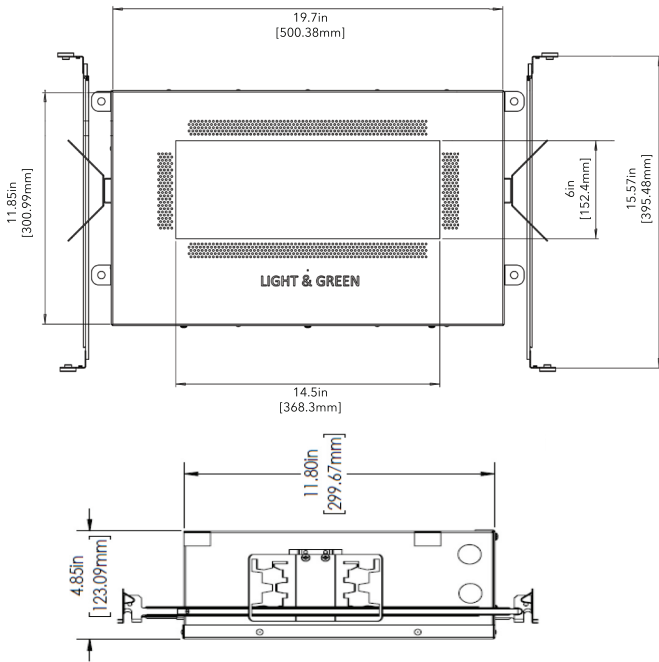
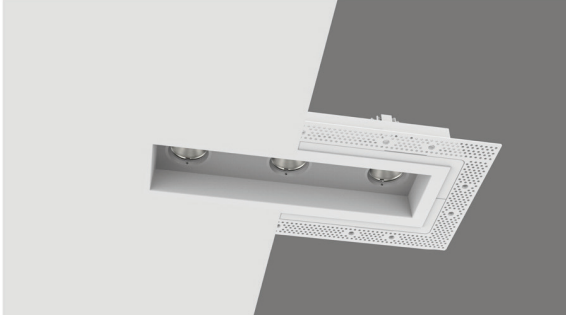

Project Address:	Project Name:
Fixture Type:	Quantity:

Universal Shallow Housing

INPUT 120V / 120-277V

HOUSING RATING - UL, cUL, IC-rated, Air Tight, CCEA (Chicago Platinum)

DRIVER - In the housing

- TRIAC/ELV < 0.01% Standard (120V only)
- 0-10V Dimming, >0.01%
- Dual Channel 0-10V Dimming for Tunable White
- Lutron Hi-lume Premier 0.1% Eco System LED Driver with soft-on, fade-to-black dimming technology
- DALI 2 Dimming, >0.01%

DRIVER - Remote

- DMX dimming, >0.01% for Tunable White

MOUNTING - Narrow housing includes adjustable mounting brackets

CEILING INSTALLATION

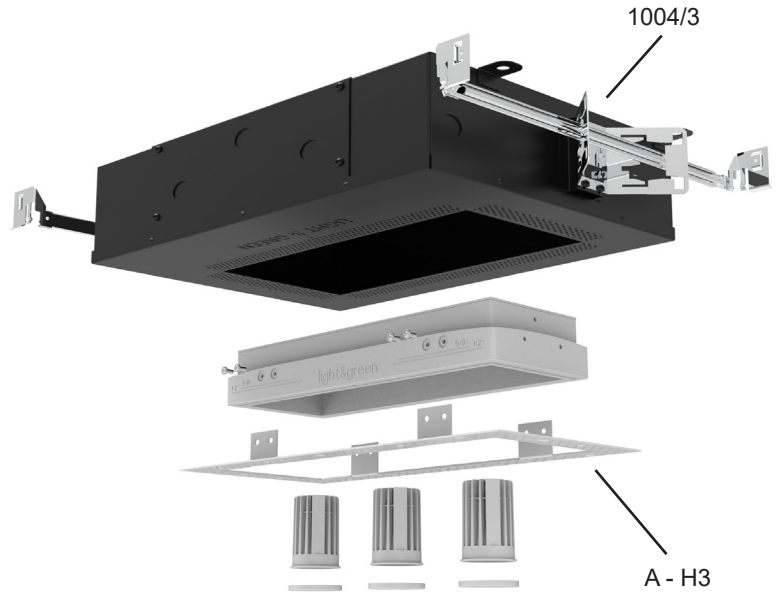

LG-9111

3" Non-adjustable Square Recessed Downlight LED- Triple

Project Address:	Project Name:
Fixture Type:	Quantity:

Specifications

LED TYPE	CL2-13W CITIZEN	CL2-18W CITIZEN	Warm Dim CL2-13WD BRIGLUXE	Warm Dim CL2-18WD BRIGLUXE	Tunable White CL2-13TW BRIGLUXE
DELIVERED LUMENS	3x1250lm (3000K)	3x1610lm (3000K)	3x940lm	3x1300lm	3x910lm
SDCM	2-STEP	2-STEP	3-STEP	3-STEP	3-STEP
WATTS	3x13W	3x18W	3x13W	3x18W	3x13W
CRI	95+				
COLOR TEMPERATURE	2700K / 3000K / 35000K / 4000K		1800K-3000K	1800K-3000K	2700K-6500K
VOLTAGE	120V / 120-277V				
DIMMING	<ul style="list-style-type: none"> • TRIAC/ELV (Down to < 0.01%) - 120V only • 0 -10 • Lutron (Hi-lume Premier 0.1% Eco System LED Driver with Soft-on, Fade-to-black dimming technology) • DALI 2 				<ul style="list-style-type: none"> • DUAL 0-10 • DMX
POWER SUPPLY	Constant current driver 36Vdc/350mA	Constant current driver 36Vdc/450mA	Constant current driver 36Vdc/350mA	Constant current driver 36Vdc/450mA	Constant current driver 36Vdc/350mA
BEAM SPREAD	15°/24°/38°/60°				
OPTICS	Soft Focus / Frosted / Linear Spread / Prismatic				
DIFFUSERS	Honeycomb				
ADJUSTABILITY	Non Adjustable				
HOUSING	IC RATED / AIR TIGHT / CCEA (CHICAGO PLENUM) / WET RATED				
FINISH	TRIMLESS/SEAMLESS				

Product Features

- Revolutionary flush mounted, trimless & seamless design
- Made out of Environmentally Friendly Plaster Materials
- Our plaster fixture can be painted using your standard paint colors
- Energy efficient LED light engines
- Versatile field changeable optics
- Dimmable with a variety of commonly used drivers
- Fixtures can be used with all Smart House Systems such as Lutron, Vantage, Control 4, Crestron and others
- Easy installation for new construction and remodel applications
- Wet Location rated
- For best results, do not paint the inside of the fixture. If painting is necessary we recommend using a spraying technique. Painting with a brush will reveal brush strokes when illuminated.

